

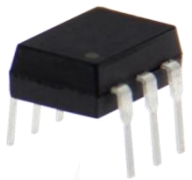



BCV412 型光 MOS 继电器

产品图片	Features 产品特性	Application 应用
 DIP6	<ul style="list-style-type: none"> ●Contact Form 触点形式 1b ●Load Voltage 输出电压 60V ●Load Current 输出电流 0.5A ●Low Off-State Leakage Current 漏电流 1.0 μA 	<ul style="list-style-type: none"> ●Automatic Test Equipment 自动检测设备 ●Security Equipment 安全设备 ●Sensing Equipment 传感设备 ●Telephone Equipment 通信设备 ●I/O Modules I/O 模块 ●Modem 调制解调器
 SMD6		

Type 种类

Output rating 输出额定		Marking model 标 刻型号	Part No. 订货型号	
Load voltage 负 载电压	Load current 负 载电流		DIP 双列直插	SMD 表面贴装
60V	0.5A	BCV412	BCV412	BCV412A

注：表示引脚类型的“A”未标刻在产品上，订货依据订货示例型号。

Dimensions 外形尺寸

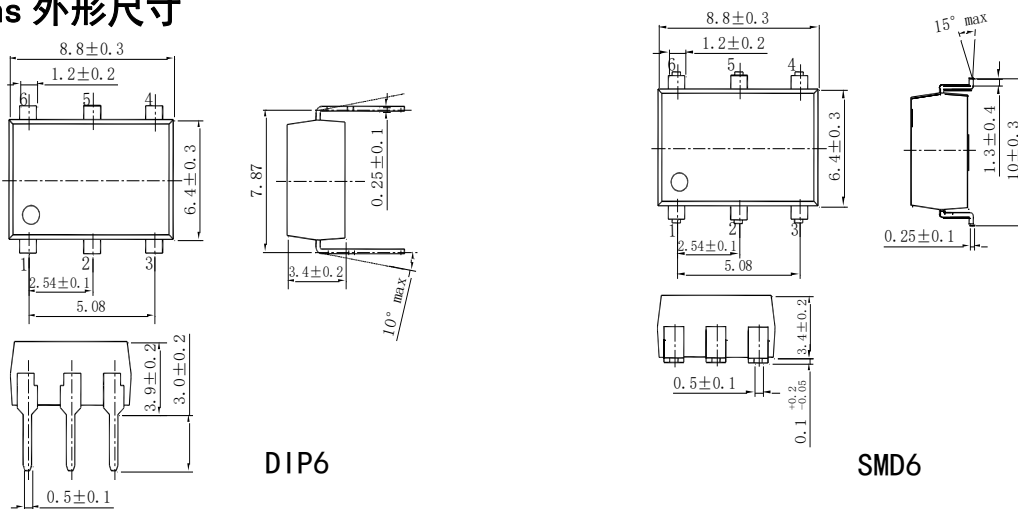

Terminal Identification 引脚标识 Wiring Diagram 接线图

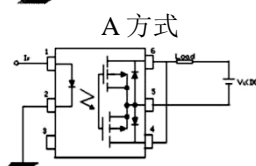
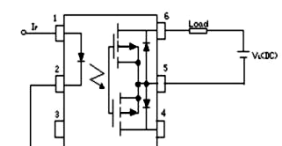
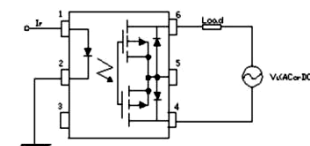
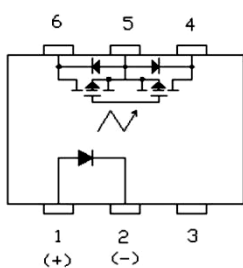

C方式

通讯地址：陕西省西安市国家民用航天产业基地航天中路385号众创广场11层1101、1102、1104室

生产地址：陕西省宝鸡市陈仓区群力路1号 邮政编码：721300

电话：(0917)-6293969 (0917)-6293785 传真：(0917)-6293969



BCV412 型光 MOS 继电器

Technical parameters 技术参数 (Ambient Temperature 25°C)

I/O Absolute Maximum Ratings 输入输出电气参数最大值

Item 项目		Symbol 符号	Value 数值
Operating Temperature 工作温度		T_{OPR}	-40°C~+85°C
Storage Temperature 储存温度		T_{STG}	-40°C~+100°C
Input 输入	Continuous LED Current 工作电流	I_F	50mA
	Peak LED Current LED 峰值电流 (f=100Hz, Duty=1%)	I_{FP}	500mA
	LED Reverse Voltage 反向电压	V_R	5V
	Input Power Dissipation 输入功耗	P_{IN}	75mW
Output 输出	Load Voltage 输出电压	V_L	60V (AC peak or DC)
	Load Current 输出电流	I_L	0.5A
	Peak Load Current 峰值输出电流 (1ms, 1 shot)	I_{PEAK}	0.6A
	Output Power Dissipation 输出功耗	P_{OUT}	300mW
Total Power Dissipation 总功耗		P_T	350mW
I/O Breakdown Voltage 输入输出间隔离电压		$V_{I/O}$	3750Vrms

Electrical Specifications 输入输出电气参数

Item 项目		Symbol 符号	MIN. 最小值	TYP. 典型值	MAX. 最大值	Units 单位	Conditions 条件
Input 输入	LED Forward Voltage 正向电压	V_F			1.4	V	$I_F=10mA$
	Operation LED Current 接通电流	$I_{F ON}$			3.0	mA	
	Recovery LED Voltage 关断电压	$V_{F OFF}$	0.5	1.0		V	
Output 输出	On-Resistance 导通电阻	R_{ON}			3	Ω	$I_F=10mA, I_L=Rating$ (with in 1sec.)
	Off-State Leakage Current 漏电流	I_{LEAK}			1.0	μA	$V_L=60V$
	Output Capacitance 输出端容量	C_{OUT}		165		pF	$V_L=0V, f=1MHz$
Time parameters 时间参数	Turn-On Time 接通时间	T_{ON}			1.0	ms	$I_F=10mA,$ $I_L=Rating$
	Turn-Off Time 关断时间	T_{OFF}			3.0	ms	
I/O 输入输出	I/O Insulation Resistance 绝缘电阻	$R_{I/O}$	1G			Ω	
	I/O Capacitance 隔离电容	$C_{I/O}$			1.5	pF	f=1MHz

通讯地址: 陕西省西安市国家民用航天产业基地航天中路385号众创广场11层1101、1102、1104室

生产地址: 陕西省宝鸡市陈仓区群力路1号 邮政编码: 721300

电话: (0917)-6293969 (0917)-6293785 传真: (0917)-6293969



Reference Data 参考数值 (BCV412)

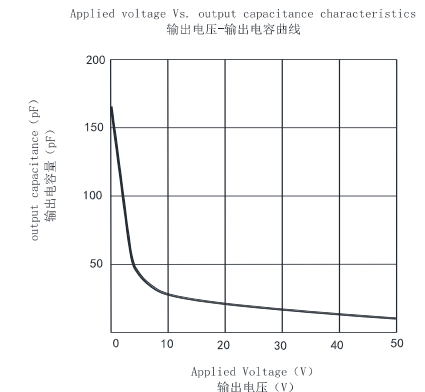
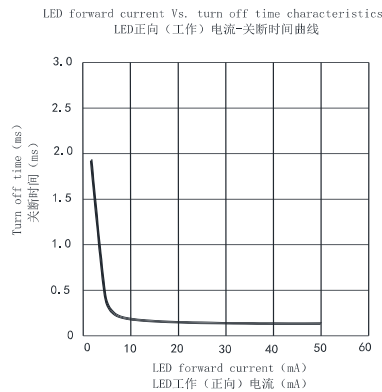
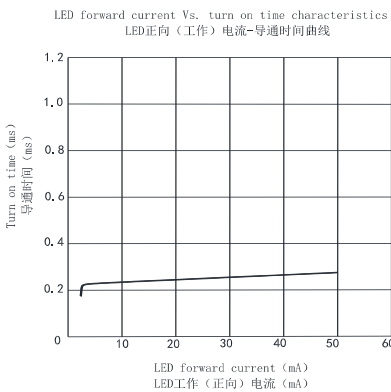
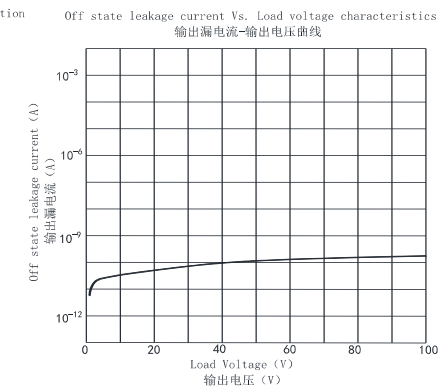
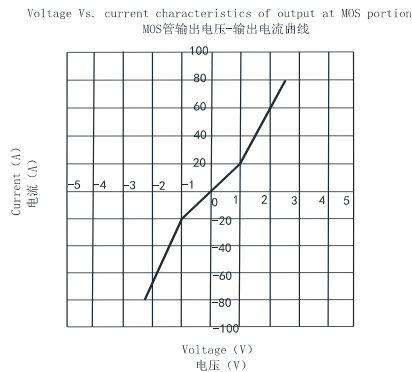
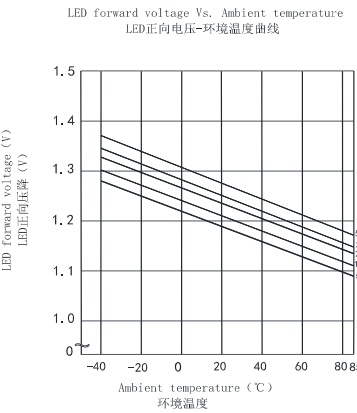
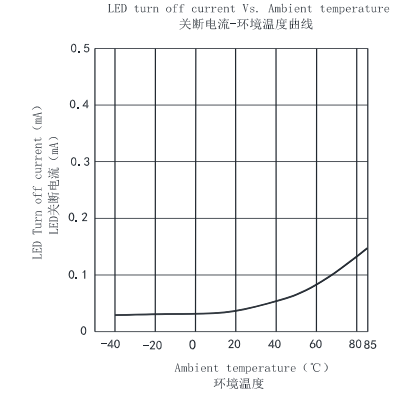
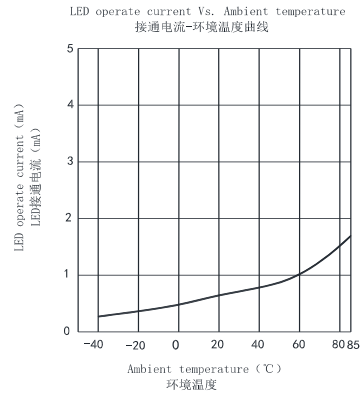
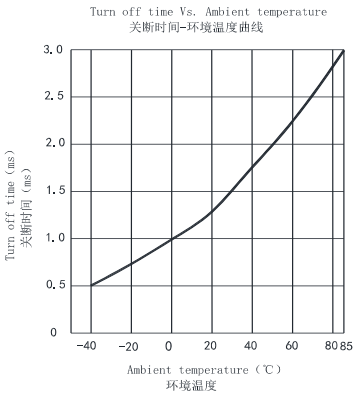
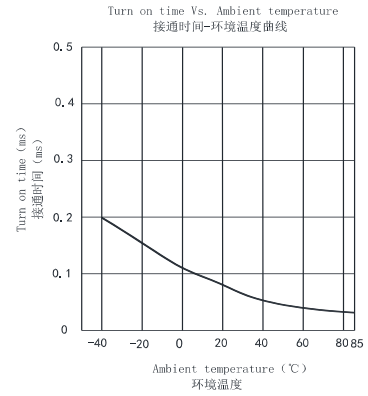
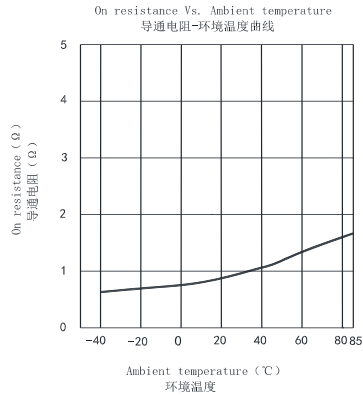
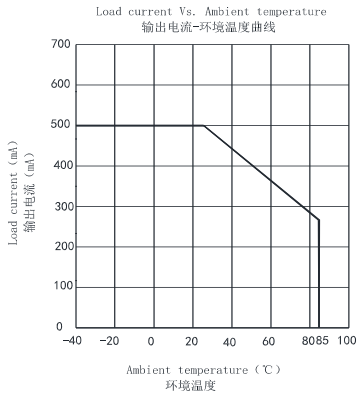

通讯地址: 陕西省西安市国家民用航天产业基地航天中路385号众创广场11层1101.1102.1104室

生产地址: 陕西省宝鸡市陈仓区群力路1号 邮政编码: 721300

电话: (0917)-6293969 18609177833 传 真: (0917)-6293969